



J



**SINALÉTICA,
NÚMEROS E LETRAS /
PICTOGRAMS, NUMBERS
AND LETTERS /
SEÑALIZACIÓN,
NÚMEROS Y LETRAS.**

SINALÉTICA / PICTOGRAMS / SEÑALIZACIÓN



IMAGEM / IMAGE:
IN.26.941+ IN.26.939.D



IMAGEM / IMAGE:
IN.26.903



IMAGEM / IMAGE:
IN.26.941+ IN.26.939.D

IN.26.9
Pictogramas com suporte em abs e fixações ocultas (placa simples) /
Pictograms with abs support and concealed fixing (single plate) /
Pictogramas con el apoyo en abs y fijación oculta (placa simple).

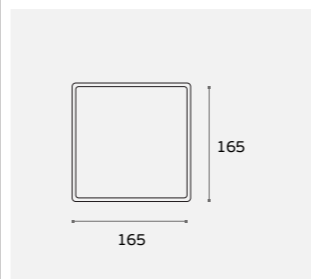

MATERIAL: EN 1.4301 / AISI 304
ACABAMENTO / FINISH / ACABADO STANDARD: SATINADO / SATIN
MATERIAL: VINIL PRETO / BLACK VINYL
DESIGN: CHRISTIAN MAGALHÃES

IN.26.9 (+) IN.26.9 .D
Pictogramas com suporte em abs e fixações ocultas (placa dupla) /
Pictograms with abs support and concealed fixing (double plate) /
Pictogramas con el apoyo en abs y fijación oculta (placa doble).

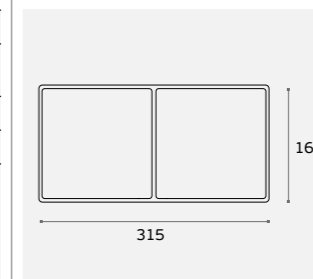

MATERIAL: EN 1.4301 / AISI 304
ACABAMENTO / FINISH / ACABADO STANDARD: SATINADO / SATIN
MATERIAL: VINIL PRETO / BLACK VINYL
DESIGN: CHRISTIAN MAGALHÃES

- | | | | | | | | | | | |
|-----|-----|-----|-----|-----|-----|-----|-----|-----|-----|-----|
| | | | | | | | | | | |
| 901 | 902 | 903 | 904 | 905 | 906 | 907 | 908 | 909 | 910 | 911 |
| | | | | | | | | | | |
| 912 | 913 | 914 | 915 | 916 | 917 | 918 | 919 | 920 | 921 | 922 |
| | | | | | | | | | | |
| 923 | 924 | 925 | 926 | 927 | 928 | 929 | 930 | 931 | 932 | 933 |
| | | | | | | | | | | |
| 934 | 935 | 936 | 937 | 938 | 939 | 940 | 941 | 942 | | |

SINALÉTICA / PICTOGRAMS / SEÑALIZACIÓN

MÚLTIPLAS SOLUÇÕES / MULTIPLE SOLUTIONS / MÚLTIPLES SOLUCIONES.



Exemplo / Example / Ejemplo
IN.26.910

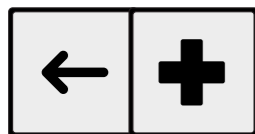

Exemplo / Example / Ejemplo
IN.26.914 (+) IN.26.915.D



Exemplo / Example / Ejemplo
IN.26.909 (+) IN.26.908.D / IN.26.914

HORIZONTAL OU VERTICAL / HORIZONTAL OR VERTICAL

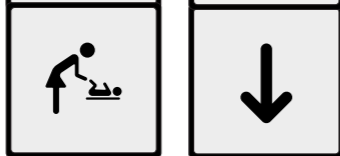
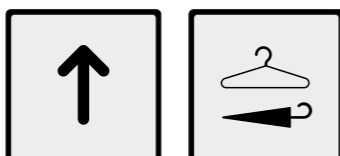
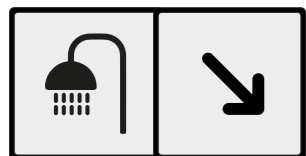
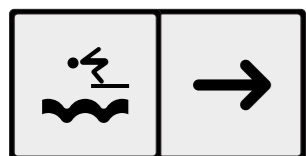

SUPORTE EM ABS /
ABS SUPPORT /
SOPORTE EM ABS.

FIXAÇÃO OCULTA POR PARAFUSO /
HIDDEN FIXING BY SCREW /
FIJACIÓN OCULTA MEDIANTE TORNILLO

ADESIVO 3M EXTRA FORTE /
EXTRA STRONG 3M ADHESIVE /
ADHESIVO 3M EXTRA FUERTE.

EN 1.4301/ AISI 304
SATINADO / SATIN

VINIL PRETO MATE /
BLACK MATTE VINYL /
VINOLO NEGRO MATE

Ambas as placas (simples ou dupla) são fornecidas com adesivo 3M extra forte e parafusos para montagem na parede /

Both plates (single or double) are supplied with extra strong 3M adhesive and screws for wall mount /

Ambos placas (sencillos o dobles) se suministran con adhesivo 3M extra fuerte y tornillos para montaje en pared /



SINALÉTICA / PICTOGRAMS / SEÑALIZACIÓN

IN.26.6__ EVOL

Pictogramas aplicados em aço inox de 1,5mm para aplicação paralela à parede. Fornecido com suporte de parede em aço inoxidável /

Stainless steel pictograms with 1,5mm thickness for application parallel to the wall. Supplied with stainless steel wall support /

Sinalética em aço inox de 1,5mm para uso paralelo a la pared. Suministrado con soporte de pared en acero inoxidable.



IMAGEM / IMAGE:
IN.26.601

MATERIAL: EN 1.4301 / AISI 304 + VINIL PRETO / BLACK VINYL / VINILO NEGRO

ACABAMENTO / FINISH / ACABADO: STANDARD: SATINADO / SATIN / SATIN

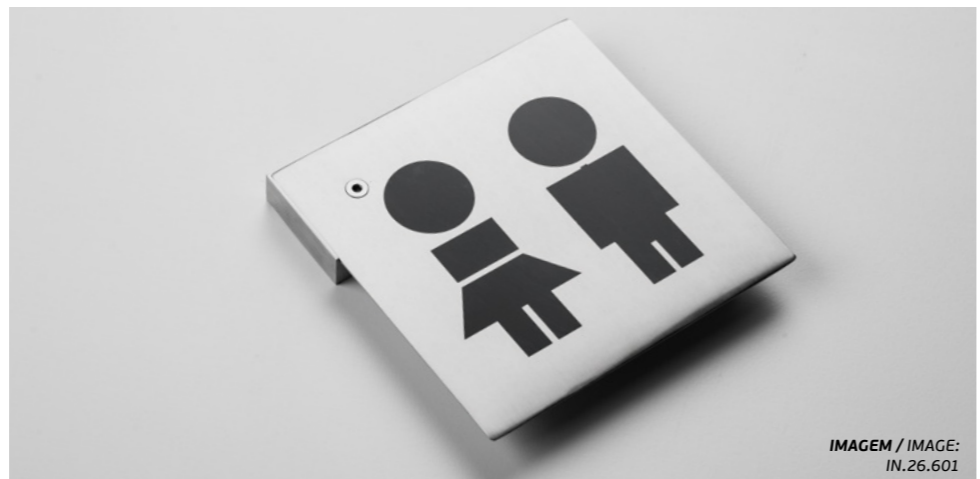
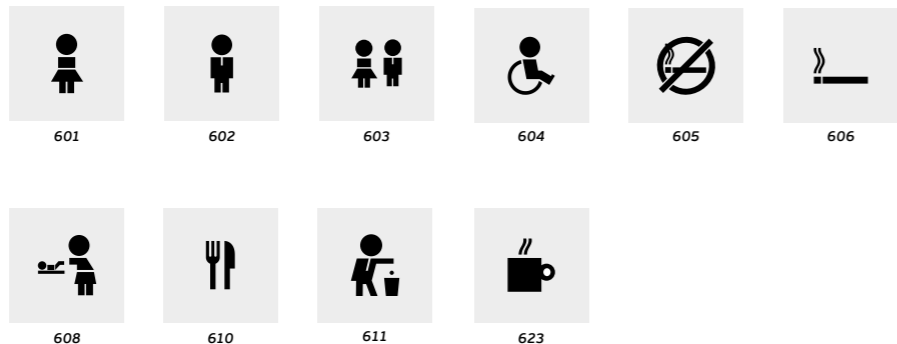
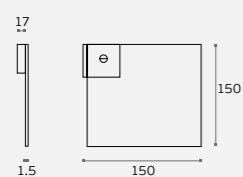

NEW

IN.26.7__

Pictogramas aplicados em aço inox de 1,5mm para aplicação paralela à parede. Fornecido com suporte de parede em aço inoxidável /

Stainless steel pictograms with 1,5mm thickness for application parallel to the wall. Supplied with stainless steel wall support /

Sinalética em aço inox de 1,5mm para uso paralelo a la pared. Suministrado con soporte de pared en acero inoxidable.



IMAGEM / IMAGE:
IN.26.708

MATERIAL: EN 1.4301 / AISI 304 + VINIL PRETO / BLACK VINYL / VINILO NEGRO

ACABAMENTO / FINISH / ACABADO: STANDARD: SATINADO / SATIN / SATIN

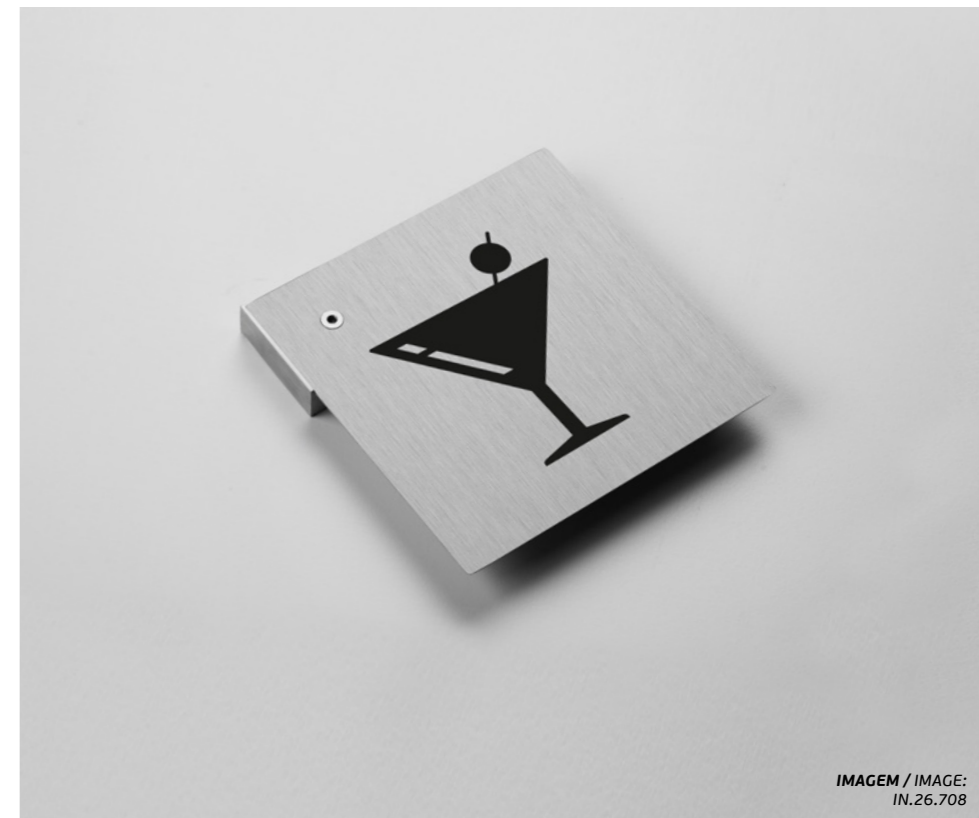
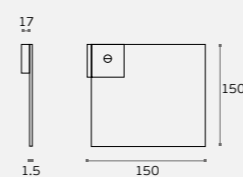

IN.26.8__ EVOL

Pictogramas aplicados em aço inox de 1,5mm para aplicação paralela à parede. Com fixação por adesivo extra-forte.

Stainless steel pictograms with 1,5mm thickness for application parallel to the wall. Strong adhesive fixing.

Sinalética em aço inox de 1,5mm para uso paralelo a la pared. Con sujeción por adhesivo extra-fuerte.



IMAGEM / IMAGE:
IN.26.801 + IN.26.802

MATERIAL: EN 1.4301 / AISI 304 + VINIL PRETO / BLACK VINYL / VINILO NEGRO

ACABAMENTO / FINISH / ACABADO: STANDARD: SATINADO / SATIN / SATIN

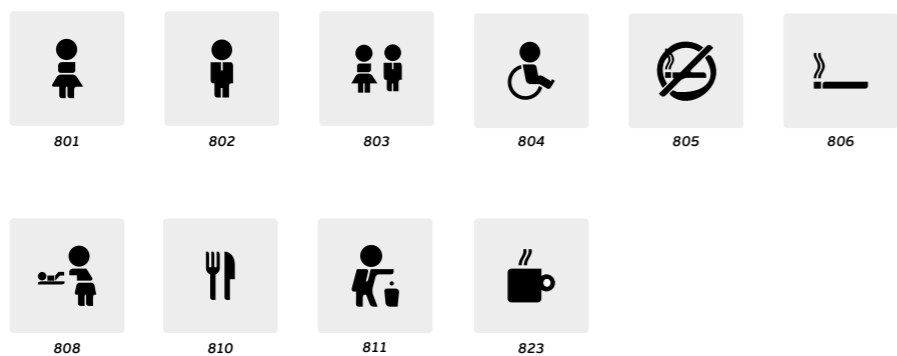
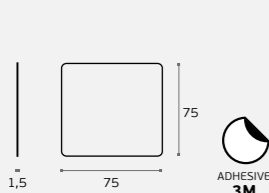

SINALÉTICA / PICTOGRAMS / SEÑALIZACIÓN



IN.26.2__

Pictogramas aplicados em aço inox de 1,5mm para aplicação paralela à parede. Com fixação por adesivo extra-forte.

Stainless steel pictograms with 1,5mm thickness for application parallel to the wall. Strong adhesive fixing.

Sinalética en acero inox de 1,5mm para uso paralelo a la pared. Con sujeción por adhesivo extra-fuerte.

MATERIAL: EN 1.4301 / AISI 304 + VINIL PRETO / BLACK VINYL / VINILO NEGRO

ACABAMENTO / FINISH / ACABADO: STANDARD: SATINADO / SATIN / SATIN

DESIGN: PEDRO SOUSA



IMAGEM / IMAGE: IN.26.235 + IN.26.242



SINALÉTICA / PICTOGRAMS / SEÑALIZACIÓN

IN.26.4__P
Pictogramas com fixação por parafusos / Pictograms with fixing system through screws / Sinalética con sujeción por tornillos.

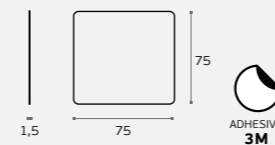
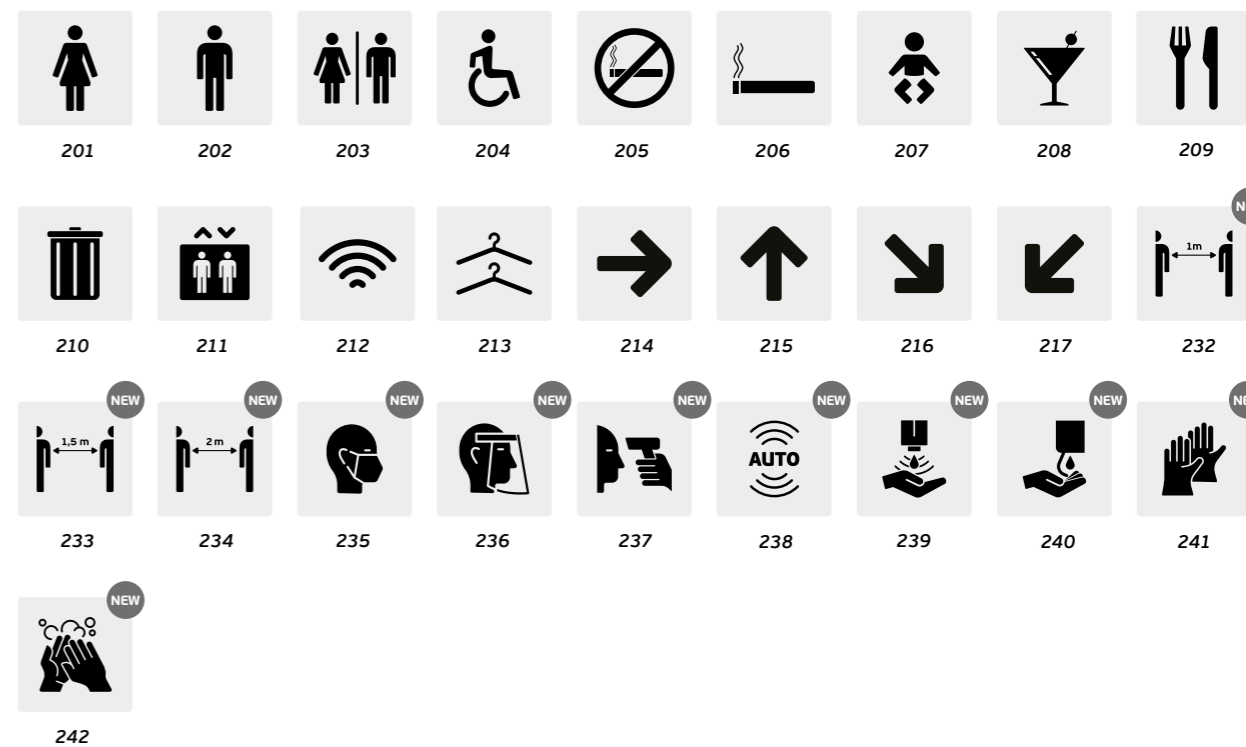
MATERIAL: EN 1.4301 / AISI 304
ACABAMENTO / FINISH / ACABADO: STANDARD: SATINADO / SATIN / SATIN

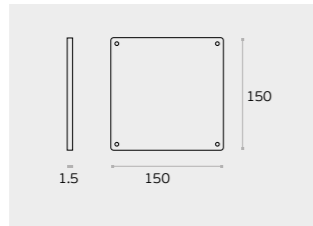

IN.26.4__A
Pictogramas com fixação por adesivo extra-forte / Pictograms with strong adhesive fixing / Sinalética con sujeción por adhesivo extra-fuerte.

MATERIAL: EN 1.4301 / AISI 304
ACABAMENTO / FINISH / ACABADO: STANDARD: SATINADO / SATIN / SATIN

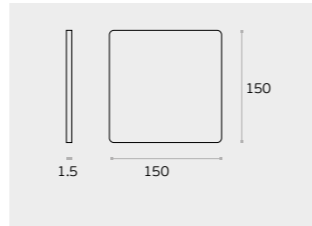

IN.26.4__S
Pictogramas com suporte para parede / Pictograms with wall mounting support / Sinalética con soporte a pared.

MATERIAL: EN 1.4301 / AISI 304
ACABAMENTO / FINISH / ACABADO: STANDARD: SATINADO / SATIN / SATIN

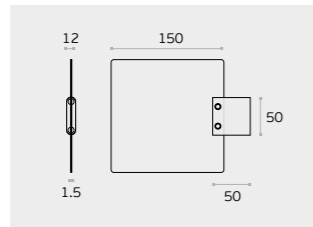

- | | | | |
|-----|-----|-----|-----|
| | | | |
| 401 | 402 | 403 | 404 |
| | | | |
| 405 | 406 | 407 | 408 |
| | | | |
| 409 | 410 | 413 | 414 |
| | | | |
| 423 | 424 | 425 | |



IMAGEM / IMAGE:
IN.26.401.S

SINALÉTICA / PICTOGRAMS / SEÑALIZACIÓN

IN.26.5_._B
IN.26.5_._M

Vinil aplicado em vidro temperado transparente. Fornecido com Suportes de parede em aço inoxidável /

Vinyl applied in tempered transparent glass. Supplied with stainless steel wall supports /

Vinil aplicado en cristal templado transparente. Suministrado con soportes de pared en acero inoxidable.

MATERIAL:
VIDRO / GLASS / CRISTAL + VINYL

(.B) PRETO / BLACK / NEGRO

(.M) CINZENTO / GREY / GRIS



IMAGEM / IMAGE:
IN.26.505.B

| | | | | | | | | |
|-----|-----|-----|-----|-----|-----|-----|-----|-----|
| | | | | | | | | |
| 501 | 502 | 503 | 504 | 505 | 506 | 507 | 508 | 509 |
| | | | | | | | | |
| 510 | 511 | 512 | 515 | 516 | 517 | 518 | 519 | 523 |
| | | | | | | | | |
| 524 | 525 | 532 | 533 | 534 | 535 | 536 | 537 | 538 |
| | | | | | | | | |
| 539 | 540 | 541 | 542 | | | | | |

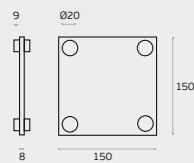

IMAGEM / IMAGE:
IN.26.411 + IN.26.412
IN.26.415.P + IN.26.416.P

SINALÉTICA / PICTOGRAMS / SEÑALIZACIÓN



IN.26.411
*Silhuetas para casa de banho com fixação por adesivo /
Bathroom indicators with strong adhesive fixing /
Indicadores de baño con sujeción por adhesivo extra fuerte.*

MATERIAL: EN 1.4301 / AISI 304
ACABAMENTO / FINISH / ACABADO:
STANDARD: SATINADO / SATIN / SATIN

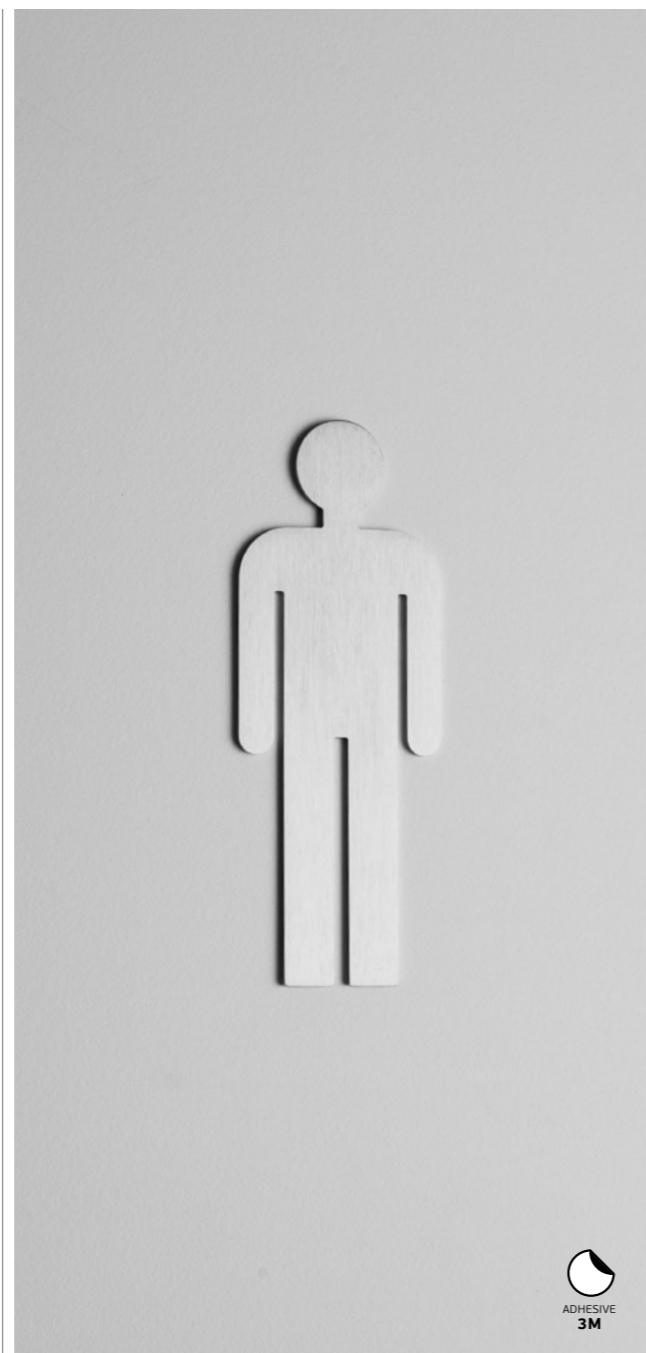
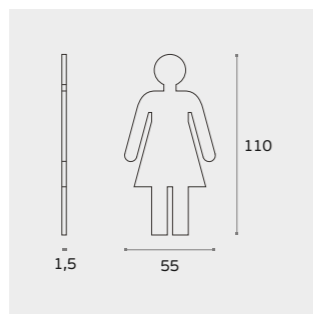

IN.26.412
*Silhuetas para casa de banho com fixação por adesivo /
Bathroom indicators with strong adhesive fixing /
Indicadores de baño con sujeción por adhesivo extra fuerte.*

MATERIAL: EN 1.4301 / AISI 304
ACABAMENTO / FINISH / ACABADO:
STANDARD: SATINADO / SATIN / SATIN

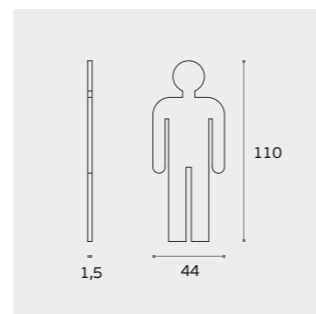

IN.26.415.P
*Silhuetas para casa de banho com fixação oculta por parafuso /
Bathroom indicators with concealed fixing at the wall /
Indicadores de toilette con sujeción oculta por tornillos.*

MATERIAL: EN 1.4301 / AISI 304
ACABAMENTO / FINISH / ACABADO:
STANDARD: SATINADO / SATIN / SATIN

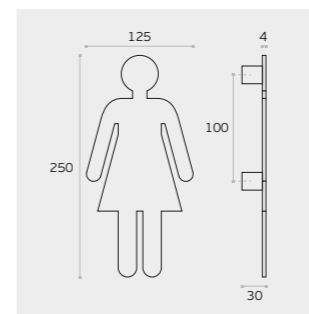

IN.26.416.P
*Silhuetas para casa de banho com fixação oculta por parafuso /
Bathroom indicators with concealed fixing at the wall /
Indicadores de toilette con sujeción oculta por tornillos.*

MATERIAL: EN 1.4301 / AISI 304
ACABAMENTO / FINISH / ACABADO:
STANDARD: SATINADO / SATIN / SATIN

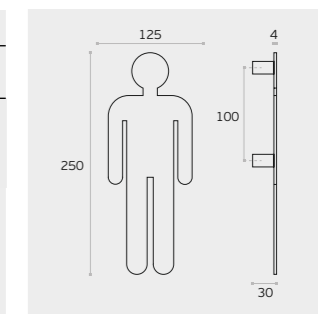

SINALÉTICA / PICTOGRAMS / SEÑALIZACIÓN

IN.34.300._

Letras e números aplicados em aço inox de 1,5mm para aplicação paralela à parede. Com fixação por adesivo extra-forte.

Stainless steel Letters and numbers with 1,5mm thickness for application parallel to the wall. Strong adhesive fixing.

Letras y numeros en acero inox de 1,5mm para uso paralelo a la pared. Con sujeción por adhesivo extra-fuerte.



IMAGEM / IMAGE: IN.34.300.8 + IN.34.300.4

MATERIAL: EN 1.4301 / AISI 304 + VINIL PRETO / BLACK VINYL / VINOLO NEGRO

ACABAMENTO / FINISH / ACABADO: STANDARD: SATINADO / SATIN / SATIN

DESIGN: PEDRO SOUSA

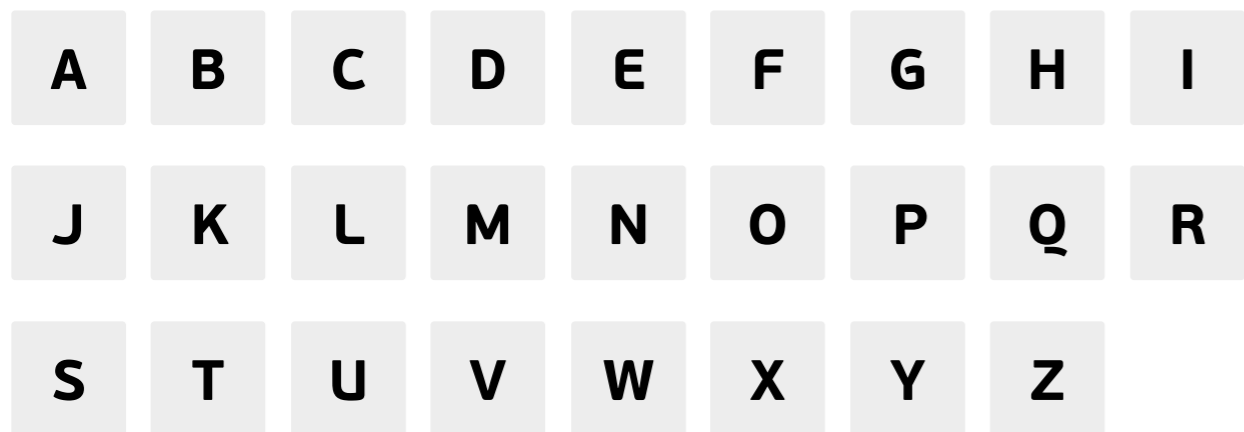
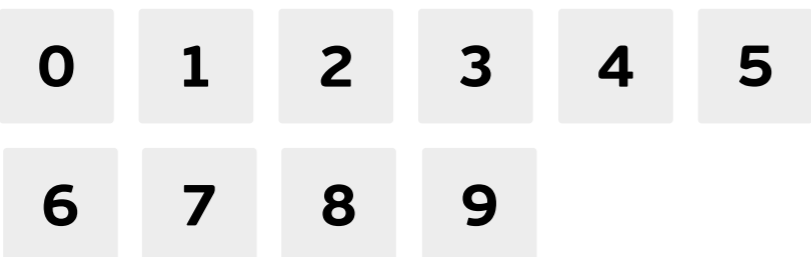
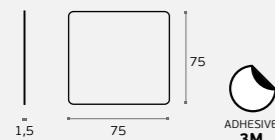

Exemplo / Example / Ejemplo

A - IN.34.300.R + IN.34.300.O + IN.34.300.O + IN.34.300.M

B - IN.34.300.2 + IN.34.300.5 + IN.34.300.8

C - IN.26.208 + IN.26.212



MÚLTIPLAS SOLUÇÕES / MULTIPLE SOLUTIONS / MÚLTIPLES SOLUCIONES



IN.26.800

Pictogramas em aço inox de 1,5mm para aplicação paralela à parede. Fornecido com suporte de parede em aço inoxidável.

Stainless steel pictograms with 1,5mm thickness for application parallel to the wall. Supplied with stainless steel wall support.

Sinalética en acero inox de 1,5mm para uso paralelo a la pared. Suministrado con soporte de pared en acero inoxidable.

MATERIAL: EN 1.4301 / AISI 304 + VINIL PRETO / BLACK VINYL / VINOLO NEGRO

ACABAMENTO / FINISH / ACABADO: STANDARD: SATINADO / SATIN / SATIN

TIPOGRAFIA / TYPEFONT: STANDARD: ARIAL BLACK

O TEXTO PRETENDIDO DEVE SER ESCRITO APÓS A REFERÊNCIA / THE INTENDED TEXT MUST BE WRITTEN AFTER THE REFERENCE / EL TEXTO PREVISTO SE DEBE ESCRIBIR DESPUÉS DE LA REFERENCIA.

Exemplo / Example / Ejemplo: IN.26.800.Showroom



IMAGEM / IMAGE: IN.26.800.SHOWROOM

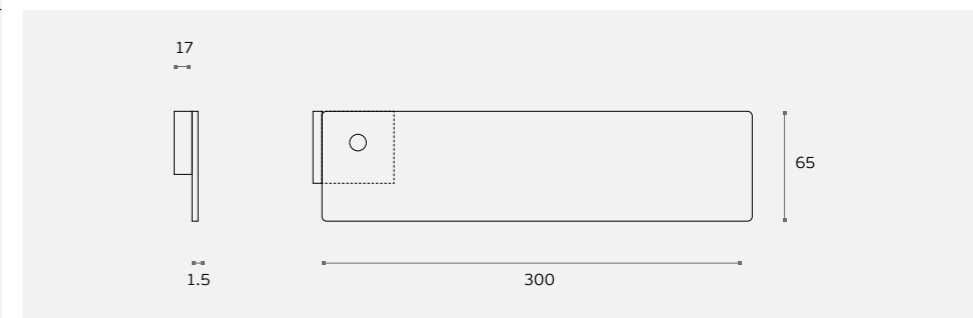

SINALÉTICA / PICTOGRAMS / SEÑALIZACIÓN



IN.26.600

Vidro temperado transparente. Fornecido com quatro Suportes de parede em aço inoxidável /

Tempered transparent glass. Supplied with four stainless steel wall supports /

Cristal templado transparente. Suministrado con cuatro soportes de pared en acero inoxidable.

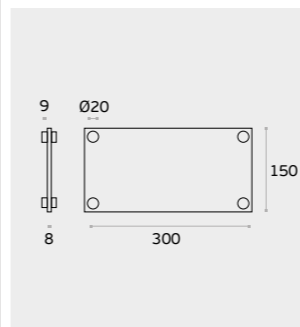

MATERIAL: VIDRO TEMPERADO / TEMPERED GLASS / CRISTAL TEMPLADO

ESPESSURA / THICKNESS: 8MM



IN.26.600.B

Vinil aplicado em vidro temperado transparente. Fornecido com Suportes de parede em aço inoxidável / Vinyl applied in tempered transparent glass. Supplied with stainless steel wall supports /

Vinil aplicado em vidro temperado transparente. Fornecido com Suportes de parede em aço inoxidável / Vinyl applied in tempered transparent glass. Supplied with stainless steel wall supports /

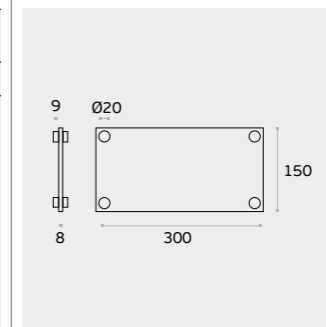

MATERIAL: VIDRO TEMPERADO / TEMPERED GLASS / CRISTAL TEMPLADO

MATERIAL: VINIL / VINYL

(.B) PRETO / BLACK / NEGRO

(.M) CINZENTO / GREY / GRIS

ESPESSURA / THICKNESS: 8MM



IN.26.700.1 IN.26.700.2

Pictogramas em aço inox de 1,5mm para aplicação paralela à parede com fixação oculta por adesivo extra-forte.

Stainless steel pictograms with 1,5mm thickness for application parallel to the wall. Supplied with concealed fixing through strong adhesive.

Sinalética en acero inox de 1,5mm para uso paralelo a la pared. Suministrado con sujeción oculta por adhesivo extra-fuerte.



IN.26.700.1
1 linha / 1 line / 1 línea



IN.26.700.2
2 linhas / 2 lines / 2 líneas

MATERIAL: EN 1.4301 / AISI 304
ACABAMENTO / FINISH / ACABADO STANDARD: SATINADO / SATIN
MATERIAL: VINIL PRETO / BLACK VINYL
TIPOGRAFIA / TYPEFONT STANDARD: PF BEAUSANS BOLD

O TEXTO PRETENDIDO DEVE SER ESCRITO APÓS A REFERÊNCIA /

THE INTENDED TEXT MUST BE WRITTEN AFTER THE REFERENCE /

EL TEXTO PREVISTO SE DEBE ESCRIBIR DESPUÉS DE LA REFERENCIA.

Exemplo / Example / Ejemplo:
IN.26.700.1.SHOWROOM
IN.26.700.2.SHOWROOM/MEETING ROOM

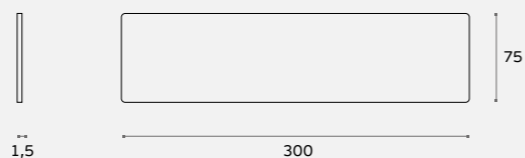

1,5

300

75



IN.34.102.B

Vinil aplicado em vidro temperado transparente. Fornecido com suportes de parede em aço inoxidável / Vinyl applied in tempered transparent glass. Supplied with stainless steel wall supports /

IN.34.102.M

Vinil aplicado em vidro temperado transparente. Fornecido com suportes de parede em aço inoxidável / Vinyl applied in tempered transparent glass. Supplied with stainless steel wall supports /



IN.80.250
EN 1.4301
Satinado / Satin
Suportes de vidro com fixação oculta.
Glass supports with hidden fixing system.
Soportes de cristal con fijación oculta.

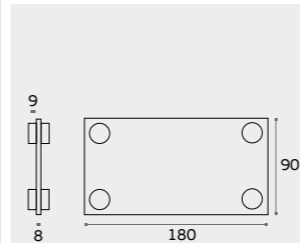
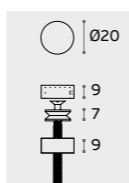

MATERIAL: VIDRO TEMPERADO / TEMPERED GLASS / CRISTAL TEMPLADO

MATERIAL: VINIL / VINYL

(.B) PRETO / BLACK / NEGRO

(.M) CINZENTO / GREY / GRIS

ESPESSURA / THICKNESS: 8MM



IN.34.100.B

Vinil aplicado em vidro temperado transparente. Fornecido com suportes de parede em aço inoxidável / Vinyl applied in tempered transparent glass. Supplied with stainless steel wall supports /

IN.34.100.M

Vinil aplicado em vidro temperado transparente. Fornecido com suportes de parede em aço inoxidável / Vinyl applied in tempered transparent glass. Supplied with stainless steel wall supports /

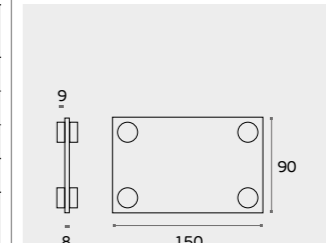

MATERIAL: VIDRO TEMPERADO / TEMPERED GLASS / CRISTAL TEMPLADO

MATERIAL: VINIL / VINYL

(.B) PRETO / BLACK / NEGRO

(.M) CINZENTO / GREY / GRIS

ESPESSURA / THICKNESS: 8MM



LETRAS / LETTERS / LETRAS

IN.34.005.P.
Letras maiúsculas com fixação oculta por parafusos à parede /
Uppercase letters with concealed fixing through wall screws /
Letras mayúsculas con sujeción oculta por tornillo.

.TB .TG .TCO .TCH

MATERIAL: EN 1.4301 / AISI 304

ACABAMENTO / FINISH / ACABADO:
STANDARD: SATINADO / SATIN / SATIN

IMAGEM / IMAGE / IMAGEN:
IN.34.005.P.C

3 |  | 10

100 |  | ABCD...Z



IN.34.005.A.
Letras maiúsculas com fixação oculta por adesivo extra-forte /
Uppercase letters with concealed fixing through strong adhesive /
Letras mayúsculas con sujeción oculta por adhesivo extra-fuerte.

MATERIAL: EN 1.4301 / AISI 304

ACABAMENTO / FINISH / ACABADO:
STANDARD: SATINADO / SATIN / SATIN

IMAGEM / IMAGE / IMAGEN:
IN.34.005.A.A

2 |  | 10

100 |  | ABCD...Z



ADHESIVE
3M

IN.34.004.P.
Letras minúsculas com fixação oculta por parafusos à parede /
Lowercase alphabets with concealed fixing through wall screws /
Letras minúsculas con sujeción oculta por tornillo.

.TB .TG .TCO .TCH

MATERIAL: EN 1.4301 / AISI 304

ACABAMENTO / FINISH / ACABADO:
STANDARD: SATINADO / SATIN / SATIN

IMAGEM / IMAGE / IMAGEN:
IN.34.004.P.B

3 |  | 10

100 |  | abcd...z





IN.34.004.A.
Letras minúsculas com fixação oculta por adesivo extra-forte /
Lowercase alphabets with concealed fixing through strong adhesive /
Letras minúsculas con sujeción oculta por adhesivo extra-fuerte.

MATERIAL: EN 1.4301 / AISI 304

ACABAMENTO / FINISH / ACABADO:
STANDARD: SATINADO / SATIN / SATIN

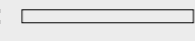
IMAGEM / IMAGE / IMAGEN:
IN.34.004.A.U

2 |  | 10

100 |  | abcd...z



ADHESIVE
3M

NEW

IN.34.PT.P.
Acentos gráficos com fixação oculta por parafusos à parede /
Graphic accentuation with concealed fixing through strong adhesive /
Acentuación gráfica con sujeción oculta por adhesivo extra-fuerte.

.TB .TG .TCO .TCH

MATERIAL: EN 1.4301 / AISI 304

ACABAMENTO / FINISH / ACABADO:
STANDARD: SATINADO / SATIN / SATIN

IMAGEM / IMAGE / IMAGEN:
IN.34.PT.P.V + IN.34.PT.P.AA

 IN.34.PT.P.C
 IN.34.PT.P.AA
 IN.34.PT.P.P
 IN.34.PT.P.V

 IN.34.PT.P.T
 IN.34.PT.P.AG
 IN.34.PT.P.H



NEW

IN.34.PT.A.
Acentos gráficos com fixação oculta por adesivo extra-forte /
Graphic accentuation with concealed fixing through strong adhesive /
Acentuación gráfica con sujeción oculta por adhesivo extra-fuerte.

MATERIAL: EN 1.4301 / AISI 304

ACABAMENTO / FINISH / ACABADO:
STANDARD: SATINADO / SATIN / SATIN

IMAGEM / IMAGE / IMAGEN:
IN.34.PT.A.V + IN.34.PT.A.AA

 IN.34.PT.A.C
 IN.34.PT.A.AA
 IN.34.PT.A.P
 IN.34.PT.A.V

 IN.34.PT.A.T
 IN.34.PT.A.G
 IN.34.PT.A.H



ADHESIVE
3M



IMAGEM / IMAGE:
IN.34.002.P.B + IN.34.005.A.P
+ IN.34.004.A.C + IN.34.004.P.B + IN.34.005.P.E

NÚMEROS /
NUMBERS / NÚMEROS



IN.34.003.A.
Algarismos com fixação oculta por adesivo extra-forte / Numerals with concealed fixing through strong adhesive / Algarismos con sujeción oculta por adhesivo extra-fuerte.

MATERIAL: EN 1.4301 / AISI 304

ACABAMENTO / FINISH / ACABADO:
STANDARD: SATINADO / SATIN / SATIN

IMAGEM / IMAGE / IMAGEN:
IN.34.003.A.7



100 | 0123456789



IN.34.000.A.
Algarismos com fixação oculta por adesivo extra-forte / Numerals with concealed fixing through strong adhesive / Algarismos con sujeción oculta por adhesivo extra-fuerte.

MATERIAL: EN 1.4301 / AISI 304

ACABAMENTO / FINISH / ACABADO:
STANDARD: SATINADO / SATIN / SATIN

IMAGEM / IMAGE / IMAGEN:
IN.34.000.A.2



150 | 0123456789



IN.34.003.P.
Algarismos com fixação oculta por parafusos à parede / Numerals with concealed fixing through wall screws / Algarismos con sujeción oculta por tornillo.



MATERIAL: EN 1.4301 / AISI 304

ACABAMENTO / FINISH / ACABADO:
STANDARD: SATINADO / SATIN / SATIN

IMAGEM / IMAGE / IMAGEN:
IN.34.003.P.5



100 | 0123456789



IN.34.000.P.
Algarismos com fixação oculta por parafusos à parede / Numerals with concealed fixing through wall screws / Algarismos con sujeción oculta por tornillo.



MATERIAL: EN 1.4301 / AISI 304

ACABAMENTO / FINISH / ACABADO:
STANDARD: SATINADO / SATIN / SATIN

IMAGEM / IMAGE / IMAGEN:
IN.34.000.P.4

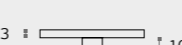

150 | 0123456789



IN.34.002.P.
Algarismos com fixação oculta por parafusos à parede / Numerals with concealed fixing through wall screws / Algarismos con sujeción oculta por tornillo.



MATERIAL: EN 1.4301 / AISI 304

ACABAMENTO / FINISH / ACABADO:
STANDARD: SATINADO / SATIN / SATIN

IMAGEM / IMAGE / IMAGEN:
IN.34.002.P.9



200 | 0123456789

